



IMO

E

Ref. T4/4.01

MSC.1/Circ.1238
30 October 2007

GUIDELINES FOR EVACUATION ANALYSIS FOR NEW AND EXISTING PASSENGER SHIPS

1 The Maritime Safety Committee, at its seventy-first session (19 to 28 May 1999), having approved MSC/Circ.909 on Interim Guidelines for a simplified evacuation analysis of ro-ro passenger ships as a guide for the implementation of SOLAS regulation II-2/28-1.3, requested the Sub-Committee on Fire Protection (FP) to also develop guidelines on evacuation analysis for passenger ships in general and high-speed passenger craft.

2 The Committee, at its seventy-fourth session (30 May to 8 June 2001), following a recommendation of the forty-fifth session of the FP Sub-Committee (8 to 12 January 2001), approved MSC/Circ.1001 on Interim Guidelines for a simplified evacuation analysis of high-speed passenger craft. The Committee, at its eightieth session (11 to 20 May 2005), after having considered a proposal by the forty-ninth session of the Sub-Committee on Fire Protection (24 to 28 January 2005) made in light of the experience gained in the application of the aforementioned Interim Guidelines, approved MSC/Circ.1166 on Guidelines for a simplified evacuation analysis of high-speed passenger craft, which supersede MSC/Circ.1001, together with the worked example appended thereto.

3 The Committee, at its seventy-fifth session (15 to 24 May 2002), further approved MSC/Circ.1033 on Interim Guidelines on evacuation analyses for new and existing passenger ships and invited Member Governments to collect and submit to the Sub-Committee on Fire Protection for further consideration, any information and data resulting from research and development activities, full-scale tests and findings on human behaviour which may be relevant for the necessary future upgrading of the present Interim Guidelines.

4 The Committee, at its eighty-third session (3 to 12 October 2007), approved the Guidelines on evacuation analyses for new and existing passenger ships, including ro-ro passenger ships, as set out in the annexes to the present circular.

5 The annexed Guidelines offer the possibility of using two distinct methods:

- .1 a simplified evacuation analysis (annex 1); and/or
- .2 an advanced evacuation analysis (annex 2).

6 The assumptions inherent within the simplified method are by their nature limiting. As the complexity of the vessel increases (through the mix of passenger types, accommodation types, number of decks and number of stairways) these assumptions become less representative of reality. In such cases, the use of the advanced method would be preferred. However, in early design iterations of the vessel, the simplified method has merit due to its relative ease of use and its ability to provide an approximation to expected evacuation performance.

7 It is also to be noted that the acceptable evacuation times in these Guidelines are based on an analysis of fire risk.

8 Member Governments are invited to bring the annexed Guidelines (annexes 1 and 2) to the attention of all those concerned and, in particular to:

- .1 recommend them to use these Guidelines when conducting evacuation analyses on new ro-ro passenger ships in compliance with SOLAS regulation II-2/28-1.3 and regulation II-2/13.7.4 (which entered into force on 1 July 2002); and
- .2 encourage them to conduct evacuation analyses on new and existing passenger ships other than ro-ro passenger ships using these Guidelines.

9 Member Governments are also encouraged to:

- .1 collect and submit to the Sub-Committee on Fire Protection for further consideration, any information and data resulting from research and development activities, full-scale tests and findings on human behaviour, which may be relevant for the necessary future upgrading of the present Guidelines;
- .2 submit to the Sub-Committee on Fire Protection information on experience gained in the implementation of the Guidelines; and
- .3 use the Guidance on validation/verification of evacuation simulation tools provided in annex 3 to the present circular when assessing the ability of evacuation simulation tools to perform an advanced evacuation analysis.

10 This circular supersedes MSC/Circ.1033.

ANNEX 1**GUIDELINES FOR A SIMPLIFIED EVACUATION ANALYSIS
FOR NEW AND EXISTING PASSENGER SHIPS****Preamble**

1 The following information is provided for consideration by, and guidance to, the users of these Guidelines:

- .1 To ensure uniformity of application, typical benchmark scenarios and relevant data are specified in the Guidelines. Therefore, the aim of the analysis is to assess the performance of the ship with regard to the benchmark scenarios rather than simulating an actual emergency.
- .2 Although the approach is, from a theoretical and mathematical point of view, sufficiently developed to deal with realistic simulations of evacuation onboard ships, there is still a shortfall in the amount of verification data and practical experience on its application. When suitable information is provided by Member Governments, the Organization should reappraise the figures, parameters, benchmark scenarios and performance standards defined in the Interim Guidelines.
- .3 Almost all the data and parameters given in the Guidelines are based on well-documented data coming from civil building experience. The data and results from ongoing research and development show the importance of such data for improving the Interim Guidelines. Nevertheless, the simulation of these benchmark scenarios are expected to improve ship design by identifying inadequate escape arrangements, congestion points and optimising evacuation arrangements, thereby significantly enhancing safety.

2 For the above considerations, it is recommended that:

- .1 the evacuation analysis be carried out as indicated in the Guidelines, in particular using the scenarios and parameters provided;
- .2 the objective should be to assess the evacuation process through benchmark cases rather than trying to model the evacuation in real emergency conditions;
- .3 application of the Guidelines to analyse actual events to the greatest extent possible, where passengers were called to assembly stations during a drill or where a passenger ship was actually evacuated under emergency conditions, would be beneficial in validating the Guidelines;
- .4 the aim of the evacuation analysis for existing passenger ships should be to identify congestion points and/or critical areas and to provide recommendations as to where these points and critical areas are located on board; and
- .5 keeping in mind that it is the ship owner's responsibility to ensure passenger and crew safety by means of operational measures, if the result of an analysis, conducted on an existing passenger ship shows that the maximum allowable evacuation time has been exceeded, then the shipowner should ensure that suitable operational measures (e.g., updates of the onboard emergency procedures, improved signage, emergency preparedness of the crew, etc.) are implemented.

1 General

1.1 The purpose of this part of the Guidelines is to present the methodology for conducting a simplified evacuation analysis and, in particular, to:

- .1 identify and eliminate, as far as practicable, congestion which may develop during an abandonment, due to normal movement of passengers and crew along escape routes, taking into account the possibility that crew may need to move along these routes in a direction opposite the movement of passengers; and
- .2 demonstrate that escape arrangements are sufficiently flexible to provide for the possibility that certain escape routes, assembly stations, embarkation stations or survival craft may be unavailable as a result of a casualty.

2 Definitions

2.1 *Persons load* is the number of persons considered in the means of escape calculations contained in chapter 13 of the Fire Safety Systems (FSS) Code (resolution MSC.98(73)).

2.2 *Awareness time (A)* is the time it takes for people to react to the situation. This time begins upon initial notification (e.g., alarm) of an emergency and ends when the passenger has accepted the situation and begins to move towards an assembly station.

2.3 *Travel time (T)* is defined as the time it takes for all persons on board to move from where they are upon notification to the assembly stations and then on to the embarkation stations.

2.4 *Embarkation time (E) and launching time (L)*, the sum of which defines the time required to provide for abandonment by the total number of persons on board.

3 Method of evaluation

The steps in the evacuation analysis specified as below.

3.1 *Description of the system:*

- .1 Identification of assembly stations.
- .2 Identification of escape routes.

3.2 *Assumptions*

This method of estimating evacuation time is basic in nature and, therefore, common evacuation analysis assumptions should be made as follows:

- .1 all passengers and crew will begin evacuation at the same time and will not hinder each other;

- .2 passengers and crew will evacuate via the main escape route, as referred to in SOLAS regulation II-2/13;
- .3 initial walking speed depends on the density of persons, assuming that the flow is only in the direction of the escape route, and that there is no overtaking;
- .4 passenger load and initial distribution are assumed in accordance with chapter 13 of the FSS Code;
- .5 full availability of escape arrangements is considered, unless otherwise stated;
- .6 people can move unhindered;
- .7 counterflow is accounted for by a counterflow correction factor; and
- .8 effects of ship's motions, passenger age and mobility impairment, flexibility of arrangements, unavailability of corridors, restricted visibility due to smoke, are accounted for in a correction factor and a safety factor. The safety factor has a value of 1.25.

3.3 Scenarios to be considered

3.3.1 As a minimum, four scenarios (cases 1, 2, 3 and 4) should be considered for the analysis as follows:

- .1 case 1 (primary evacuation case, night) and case 2 (primary evacuation case, day) in accordance with chapter 13 of the FSS Code; and
- .2 cases 3 and 4 (secondary evacuation cases). In these cases only the main vertical zone, which generates the longest travel time, is further investigated. These cases utilize the same population demographics as in case 1 (for case 3) and as in case 2 (for case 4). The following are two alternatives that should be considered for both case 3 and case 4. Alternative 1 should be considered if possible:
 - .2.1 alternative 1: one complete run of the stairways having largest capacity previously used within the identified main vertical zone is considered unavailable for the simulation; or
 - .2.2 alternative 2: 50% of the persons in one of the main vertical zones neighbouring the identified main vertical zone are forced to move into the zone and to proceed to the relevant assembly. The neighbouring zone with the largest population should be selected.

3.3.2 If the total number of persons on board calculated, as indicated in the above cases, exceeds the maximum number of persons the ship will be certified to carry, the initial distribution of people should be scaled down so that the total number of persons is equal to what the ship will be certified to carry.

3.3.3 Additional relevant scenarios may be considered as appropriate.

3.4 *Calculation of the evacuation time*

The following components should be considered:

- .1 awareness time (A) should be 10 min for the night time scenarios and 5 min for the day time scenarios;
- .2 method to calculate the travel time (T) is given in appendix 1; and
- .3 embarkation time (E) and launching time (L).

3.5 *Performance standards*

3.5.1 The following performance standards, as illustrated in figure 3.5.3, should be complied with:

$$\text{Calculated total evacuation time: } 1.25 (A + T) + 2/3 (E + L) \leq n \quad (1)$$

$$E + L \leq 30 \text{ min} \quad (2)$$

3.5.2 In performance standard (1):

- .1 for ro-ro passenger ships, $n = 60$; and
- .2 for passenger ships other than ro-ro passenger ships, $n = 60$ if the ship has no more than three main vertical zones; and 80, if the ship has more than three main vertical zones.

3.5.3 Performance standard (2) complies with SOLAS regulation III/21.1.4.

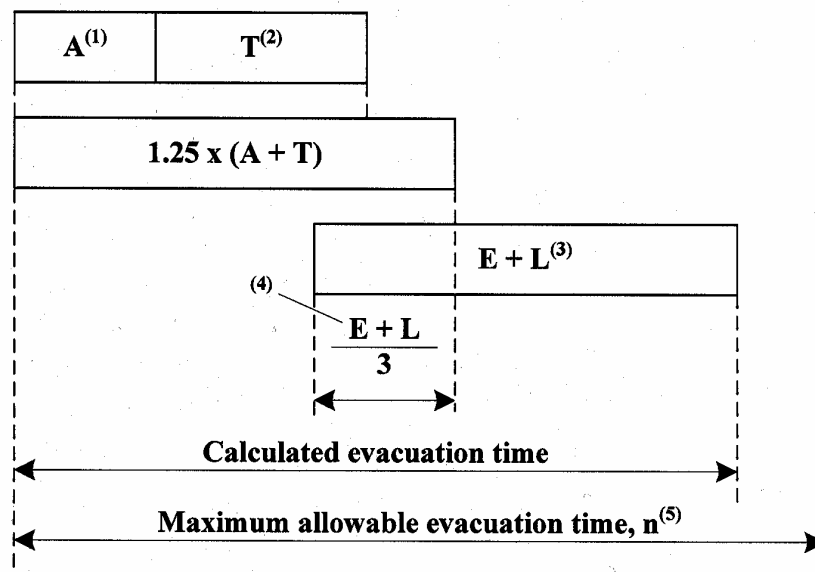

- (1) 10 min in case 1 and case 3, 5 min in case 2 and case 4
- (2) calculated as in appendix 1 to these Guidelines
- (3) maximum 30 min in compliance with SOLAS regulation III/21.1.4
- (4) overlap time = $\frac{1}{3} (E+L)$
- (5) values of n (min) provided in 3.5.2

Figure 3.5.3

3.6 Calculation of $E + L$

3.6.1 $E + L$ should be calculated separately based upon:

- .1 results of full scale trials on similar ships and evacuation systems; or
- .2 data provided by the manufacturers. However, in this case, the method of calculation should be documented, including the value of correction factor used.

3.6.2 For cases where neither of the two above methods can be used, $E + L$ should be assumed equal to 30 min.

3.7 Identification of congestion

Congestion is identified by either of the following criteria:

- .1 initial density equal to, or greater than, 3.5 persons/m²; or
- .2 significant queues (accumulation of more than 1.5 persons per second between ingress and exit from a point).

4 Corrective actions

4.1 For new ships, if the total evacuation time calculated, as described in paragraph 3.5 above, is in excess of the required total evacuation time, corrective actions should be considered at the design stage by suitably modifying the arrangements affecting the evacuation system in order to reach the required total evacuation time.

4.2 For existing ships, if the total evacuation time calculated, as described in paragraph 3.5 above, is in excess of the required total evacuation time, on-board evacuation procedures should be reviewed with a view toward taking appropriate actions which would reduce congestion which may be experienced in locations as indicated by the analysis.

5 Documentation

The documentation of the analysis should report on the following items:

- .1 basic assumptions for the analysis;
- .2 schematic representation of the layout of the zones subjected to the analysis;
- .3 initial distribution of persons for each considered scenario;
- .4 methodology used for the analysis if different from these Interim Guidelines;
- .5 details of the calculations;
- .6 total evacuation time; and
- .7 identified congestion points.

APPENDIX 1

METHOD TO CALCULATE THE TRAVEL TIME (T)

1 PARAMETERS TO BE CONSIDERED

1.1 Clear width (W_c)

Clear width is measured off the handrail(s) for corridors and stairways and the actual passage width of a door in its fully open position.

1.2 Initial density of persons (D)

The initial density of persons in an escape route is the number of persons (p) divided by the available escape route area pertinent to the space where the persons are originally located and expressed in (p/m^2).

1.3 Speed of persons (S)

The speed (m/s) of persons along the escape route depends on the specific flow of persons (as defined in 1.4) and on the type of escape facility. People speed values are given in tables 1.1 (initial speed) and 1.3 below (speed after transition point as a function of specific flow).

1.4 Specific flow of persons (F_s)

Specific flow ($p/(ms)$) is the number of escaping persons past a point in the escape route per unit time per unit of clear width W_c of the route involved. Values of F_s are given, in table 1.1 (initial F_s as a function of initial density) and in table 1.2 (maximum value) below.

Table 1.1* - Values of initial specific flow and initial speed as a function of density

Type of facility	Initial density D (p/m^2)	Initial specific flow F_s ($p/(ms)$)	Initial speed of persons S (m/s)
Corridors	0	0	1.2
	0.5	0.65	1.2
	1.9	1.3	0.67
	3.2	0.65	0.20
	≥ 3.5	0.32	0.10

Table 1.2* - Value of maximum specific flow

Type of facility	Maximum specific flow F_s ($p/(ms)$)
Stairs (down)	1.1
Stairs (up)	0.88
Corridors	1.3
Doorways	1.3

* Data derived from land-based stairs, corridors and doors in civil building and extracted from the publication "SFPE Fire Protection Engineering Handbook, 2nd edition, NFPA 1995".

Table 1.3* - Values of specific flow and speed

Type of facility	Specific flow F_s (p/(ms))	Speed of persons S (m/s)
Stairs (down)	0	1.0
	0.54	1.0
	1.1	0.55
Stairs (up)	0	0.8
	0.43	0.8
	0.88	0.44
Corridors	0	1.2
	0.65	1.2
	1.3	0.67

1.5 Calculated flow of persons (F_c)

The calculated flow of persons (p/s) is the predicted number of persons passing a particular point in an escape route per unit time. It is obtained from:

$$F_c = F_s W_c \quad (1.5)$$

1.6 Flow time (t_F)

Flow time (s) is the total time needed for N persons to move past a point in the egress system, and is calculated as:

$$t_F = N / F_c \quad (1.6)$$

1.7 Transitions

Transitions are those points in the egress system where the type (e.g., from a corridor to a stairway) or dimension of a route changes or where routes merge or ramify. In a transition, the sum of all the outlet-calculated flow is equal to the sum of all the inlet-calculated flow:

$$\sum F_c(in)_i = \sum F_c(out)_j \quad (1.7)$$

where:

$F_c(in)_i$ = calculated flow of route (i) arriving at transition point

$F_c(out)_j$ = calculated flow of route (j) departing from transition point

1.8 Travel time T , correction factor and counterflow correction factor

Travel time T expressed in seconds as given by:

$$T = (\gamma + \delta) t_I \quad (1.8)$$

where:

γ = is the correction factor to be taken equal to 2 for cases 1 and 2 and 1.3 for cases 3 and 4;

δ = is the counterflow correction factor to be taken equal to 0.3; and

* Data derived from land-based stairs, corridors and doors in civil building and extracted from the publication "SFPE Fire Protection Engineering Handbook, 2nd edition, NFPA 1995".

t_I = is the highest travel time expressed in seconds in ideal conditions resulting from application of the calculation procedure outlined in paragraph 2 of this appendix.

2 Procedure for calculating the travel time in ideal conditions

2.1 Symbols

To illustrate the procedure, the following notation is used:

t_{stair} = stairway travel time(s) of the escape route to the assembly station

t_{deck} = travel time(s) to move from the farthest point of the escape route of a deck to the stairway

$t_{assembly}$ = travel time(s) to move from the end of the stairway to the entrance of the assigned assembly station

2.2 Quantification of flow time

The basic steps of the calculation are the following:

- .1 Schematization of the escape routes as a hydraulic network, where the pipes are the corridors and stairways, the valves are the doors and restrictions in general, and the tanks are the public spaces.
- .2 Calculation of the density D in the main escape routes of each deck. In the case of cabin rows facing a corridor, it is assumed that the people in the cabins simultaneously move into the corridor; the corridor density is therefore the number of cabin occupants per corridor unit area calculated considering the clear width. For public spaces, it is assumed that all persons simultaneously begin the evacuation at the exit door (the specific flow to be used in the calculations is the door's maximum specific flow); the number of evacuees using each door may be assumed proportional to the door clear width.
- .3 Calculation of the initial specific flows F_s , by linear interpolation from table 1.1, as a function of the densities.
- .4 Calculation of the flow F_c for corridors and doors, in the direction of the correspondent assigned escape stairway.
- .5 Once a transition point is reached; formula (1.7) is used to obtain the outlet calculated flow(s) F_c . In cases where two or more routes leave the transition point, it is assumed that the flow F_c of each route is proportional to its clear width. The outlet specific flow(s), F_s , is obtained as the outlet calculated flow(s) divided by the clear width(s); two possibilities exist:
 - .1 F_s does not exceed the maximum value of table 1.2; the corresponding outlet speed (S) is then taken by linear interpolation from table 1.3, as a function of the specific flow; or

- .2 F_s exceeds the maximum value of table 1.2 above; in this case, a queue will form at the transition point, F_s is the maximum of table 1.2 and the corresponding outlet speed (S) is taken from table 1.3.
- .6 The above procedure is repeated for each deck, resulting in a set of values of calculated flows F_c and speed S , each entering the assigned escape stairway.
- .7 Calculation, from N (number of persons entering a flight or corridor) and from the relevant F_c , of the flow time t_F of each stairway and corridor. The flow time t_F of each escape route is the longest among those corresponding to each portion of the escape route.
- .8 Calculation of the travel time t_{deck} from the farthest point of each escape route to the stairway, is defined as the ratio of length/speed. For the various portions of the escape route, the travel times should be summed up if the portions are used in series, otherwise the largest among them should be adopted. This calculation should be performed for each deck; as the people are assumed to move in parallel on each deck to the assigned stairway, the dominant value t_{deck} should be taken as the largest among them. No t_{deck} is calculated for public spaces.
- .9 Calculation, for each stair flight, of its travel time as the ratio of inclined stair flight length and speed. For each deck, the total stair travel time, t_{stair} , is the sum of the travel times of all stairs flights connecting the deck with the assembly station.
- .10 Calculation of the travel time t assembly from the end of the stairway (at the assembly station deck) to the entrance of the assembly station.
- .11 The overall time to travel along an escape route to the assigned assembly station is:
- $$t_I = t_F + t_{deck} + t_{stair} + t_{assembly} \quad (2.2.11)$$
- .12 The procedure should be repeated for both the day and night cases. This will result in two values (one for each case) of t_I for each main escape route leading to the assigned assembly station.
- .13 Congestion points are identified as follows:
- .1 in those spaces where the initial density is equal, or greater than, 3.5 persons/m²; and
- .2 in those locations where the difference between inlet and outlet calculated flows (F_C) is in more than 1.5 persons per second.
- .14 Once the calculation is performed for all the escape routes, the highest t_I should be selected for calculating the travel time T using formula (1.8).

APPENDIX 2

EXAMPLE OF APPLICATION

1 *General*

1.1 This example provides an illustration on the application of the Interim Guidelines regarding cases 1 and 2. Therefore it should not be viewed as a comprehensive and complete analysis nor as an indication of the data to be used.

1.2 The present example refers to an early design analysis of arrangements of a hypothetical new cruise ship. Moreover, the performance standard is assumed to be 60 min, as for ro-ro passenger ships. It should be noted that, at the time this example was developed, no such requirement is applicable for passenger ships other than ro-ro passenger ships. This example is therefore to be considered purely illustrative.

2 *Ship characteristics*

2.1 The example is limited to two main vertical zones (MVZ 1 and MVZ 2) of a hypothetical cruise ship. For MVZ 1, a night scenario is considered, hereinafter called case 1 (see figure 1) while a day scenario (case 2, see figure 2) is considered for MVZ 2.

2.2 In case 1, the initial distribution corresponds to a total of 449 persons located in the crew and passengers cabins as follows: 42 in deck 5; 65 in deck 6 (42 in the fore part and 23 in the aft part); 26 in deck 7; 110 in deck 9; 96 in deck 10; and 110 in deck 11. Deck 8 (assembly station) is empty.

2.3 In case 2, the initial distribution corresponds to a total of 1138 persons located in the public spaces as follows: 469 in deck 6; 469 in deck 7; and 200 in deck 9. Deck 8 (assembly station) is empty.

3 *Description of the system*

3.1 *Identification of assembly stations*

For both MVZ 1 and MVZ 2, the assembly stations are located at deck 8, which is also the embarkation deck.

3.2 *Identification of escape routes*

3.2.1 In MVZ 1, the escape routes are as follows (see figure 3):

- .1 Deck 5 is connected with deck 6 (and then deck 8 where assembly stations are located) through one stair (stair A) in the fore part of the zone. Four corridors (corridors 1, 2, 3 and 4) and two doors (respectively door 1 and 2) connect the cabins with stair A. The clear widths and lengths are:

Item	Wc (clear width)[m]	Length [m]	Area [m ²]	Notes
MVZ1 – deck 5 – corridor 1	0.9	13	11.7	To door 1
MVZ1 – deck 5 – corridor 2	0.9	20	18	To door 1
MVZ1 – deck 5 – corridor 3	0.9	9.5	8.55	To door 2
MVZ1 – deck 5 – corridor 4	0.9	20	18	To door 1
MVZ1 – deck 5 – door 1	0.9	N.A.	N.A.	To stair A
MVZ1 – deck 5 – door 2	0.9	N.A.	N.A.	To stair A
MVZ1 – deck 5 – stair A	1.35	4.67	N.A.	Up to deck 6

- .2 Deck 6 is connected with deck 7 (and then deck 8) through two stairs (stairs A and B respectively in the fore and aft part of the zone). Four corridors (corridors 1, 2, 3 and 4) and two doors (doors 1 and 2) connect the fore cabins with stair A; and two corridors (corridors 5 and 6) and two doors (doors 3 and 4) connect the aft cabins with stair B. The clear widths and lengths are:

Item	Wc (clear width)[m]	Length [m]	Area [m ²]	Notes
MVZ1 – deck 6 – corridor 1	0.9	13	11.7	To door 1
MVZ1 – deck 6 – corridor 2	0.9	20	18	To door 1
MVZ1 – deck 6 – corridor 3	0.9	9.5	8.55	To door 2
MVZ1 – deck 6 – corridor 4	0.9	20	18	To door 1
MVZ1 – deck 6 – door 1	0.9	N.A.	N.A.	To stair A
MVZ1 – deck 6 – door 2	0.9	N.A.	N.A.	To stair A
MVZ1 – deck 6 – stair A	1.35	4.67	N.A.	Up to deck 7
MVZ1 – deck 6 – corridor 5	0.9	13	11.7	To door 3
MVZ1 – deck 6 – corridor 6	0.9	20	18	To door 4
MVZ1 – deck 6 – door 3	0.9	N.A.	N.A.	To stair B
MVZ1 – deck 6 – door 4	0.9	N.A.	N.A.	To stair B
MVZ1 – deck 6 – stair B	1.35	4.67	N.A.	Up to deck 7

- .3 Deck 7 is connected with deck 8 through stair C (stairs A and B coming from below stop at deck 7). Arrival of stairs A and B and deck 7 cabins are connected to stair C through 8 corridors, doors are neglected here in view of simplifying this example. The clear widths and lengths are:

Item	Wc (clear width)[m]	Length [m]	Area [m ²]	Notes
MVZ1 – deck 7 – corridor 1	0.9	6	5.4	To stair C
MVZ1 – deck 7 – corridor 2	0.9	9	8.1	To corridor 7
MVZ1 – deck 7 – corridor 3	0.9	15	13.5	To corridor 8
MVZ1 – deck 7 – corridor 4	0.9	6	5.4	To stairway C
MVZ1 – deck 7 – corridor 5	0.9	14	12.6	To corridor 7
MVZ1 – deck 7 – corridor 6	0.9	15	13.5	To corridor 8
MVZ1 – deck 7 – corridor 7	2.4	11	26.4	From stair B
MVZ1 – deck 7 – corridor 8	2.4	9	21.6	From stair A to stair C
MVZ1 – deck 7 – stair C	1.40	4.67	N.A.	Up to deck 8

- .4 Deck 11 is connected with deck 10 through a double stair (stair C) in the aft part of the zone. Two corridors (corridor 1 and 2) connect the cabins with stair C through two doors (respectively doors 1 and 2). The clear widths and lengths are:

Item	Wc (clear width)[m]	Length [m]	Area [m ²]	Notes
MVZ1 – deck 11 – corridor 1	0.9	36	32.4	To door 1
MVZ1 – deck 11 – corridor 2	0.9	36	32.4	To door 2
MVZ1 – deck 11 – door 1	0.9	N.A.	N.A.	To stair C
MVZ1 – deck 11 – door 2	0.9	N.A.	N.A.	To stair C
MVZ1 – deck 11 – stair C	2.8	4.67	N.A.	down to deck 10

- .5 Deck 10 has a similar arrangement as deck 11. The clear widths and lengths are:

Item	Wc (clear width)[m]	Length [m]	Area [m ²]	Notes
MVZ1 – deck 10 – corridor 1	0.9	36	32.4	To door 1
MVZ1 – deck 10 – corridor 2	0.9	36	32.4	To door 2
MVZ1 – deck 10 – door 1	0.9	N.A.	N.A.	To stair C
MVZ1 – deck 10 – door 2	0.9	N.A.	N.A.	To stair C
MVZ1 – deck 10 – stair C	2.8	4.67	N.A.	down to deck 9

- .6 Deck 9 has a similar arrangement as deck 11. The clear widths and lengths are:

Item	Wc (clear width)[m]	Length [m]	Area [m ²]	Notes
MVZ1 – deck 9 – corridor 1	0.9	36	32.4	To door 1
MVZ1 – deck 9 – corridor 2	0.9	36	32.4	To door 2
MVZ1 – deck 9 – door 1	0.9	N.A.	N.A.	To stair C
MVZ1 – deck 9 – door 2	0.9	N.A.	N.A.	To stair C
MVZ1 – deck 9 – stair C	2.8	4.67	N.A.	down to deck 8

- .7 Deck 8, people coming from decks 5, 6 and 7 (stair C) and from decks 11, 10 and 9 (stair C) enters the assembly station through paths 1 and 2. The clear widths and lengths are:

Item	Wc (clear width)[m]	Length [m]	Notes
MVZ1 – deck 8 – path 1	2.00	9.50	to assembly station
MVZ1 – deck 8 – path 2	2.50	7.50	to assembly station

3.2.2 In MVZ 2, the escape routes are as follows (see figure 4):

- .1 Deck 6 is connected with deck 7 (and then deck 8 where assembly stations are located) through two stairs (stair A and B respectively) in the fore part of the zone and through a double stair (stair C) in the aft part of the zone. Two doors (respectively door A and B) connect the public space with stairs A and B; and two doors (respectively door port side (PS) and door starboard side (SB)) connect the public space with stair C. The clear widths and lengths are:

Item	Wc (clear width)[m]	Length [m]	Notes
MVZ2 – deck 6 – door A	1	N.A.	
MVZ2 – deck 6 – door B	1	N.A.	
MVZ2 – deck 6 – door C PS	1.35	N.A.	
MVZ2 – deck 6 – door C SB	1.35	N.A.	
MVZ2 – deck 6 – stair A	1.4	4.67	up to deck 7
MVZ2 – deck 6 – stair B	1.4	4.67	up to deck 7
MVZ2 – deck 6 – stair C	3.2	4.67	up to deck 7

- .2 deck 7 is connected with deck 8 through the same arrangements as deck 6 to deck 7. The clear widths and lengths are:

Item	Wc (clear width)[m]	Length [m]	Notes
MVZ2 – deck 7 – door A	1.7	N.A.	
MVZ2 – deck 7 – door B	1.7	N.A.	
MVZ2 – deck 7 – door C PS	0.9	N.A.	
MVZ2 – deck 7 – door C SB	0.9	N.A.	
MVZ2 – deck 7 – stair A	2.05	4.67	up to deck 8
MVZ2 – deck 7 – stair B	2.05	4.67	up to deck 8
MVZ2 – deck 7 – stair C	3.2	4.67	up to deck 8

- .3 Deck 9 is connected with deck 8 through a double stair (stair C) in the aft part of the zone. Two doors (respectively door PS and door SB) connect the public space with stair C. The clear widths and lengths are:

Item	Wc (clear width)[m]	Length [m]	Notes
MVZ2 – deck 9 – door C PS	1	N.A.	
MVZ2 – deck 9 – door C SB	1	N.A.	
MVZ2 – deck 9 – stair C	3.2	4.67	down to deck 7

- .4 Deck 8, people coming from decks 6 and 7 (stairs A and B) enter directly the embarkation station (open deck) through doors A and B, while people coming from deck 9 (stair C) enter the assembly (muster) station through paths 1 and 2. The clear widths and lengths are:

Item	Wc (clear width)[m]	Length [m]	Notes
MVZ2 – deck 8 – door A	2.05	N.A.	to embarkation station
MVZ2 – deck 8 – door B	2.05	N.A.	to embarkation station
MVZ2 – deck 8 – path 1	2	9.5	to assembly station
MVZ2 – deck 8 – path 2	2.5	7.5	to assembly station

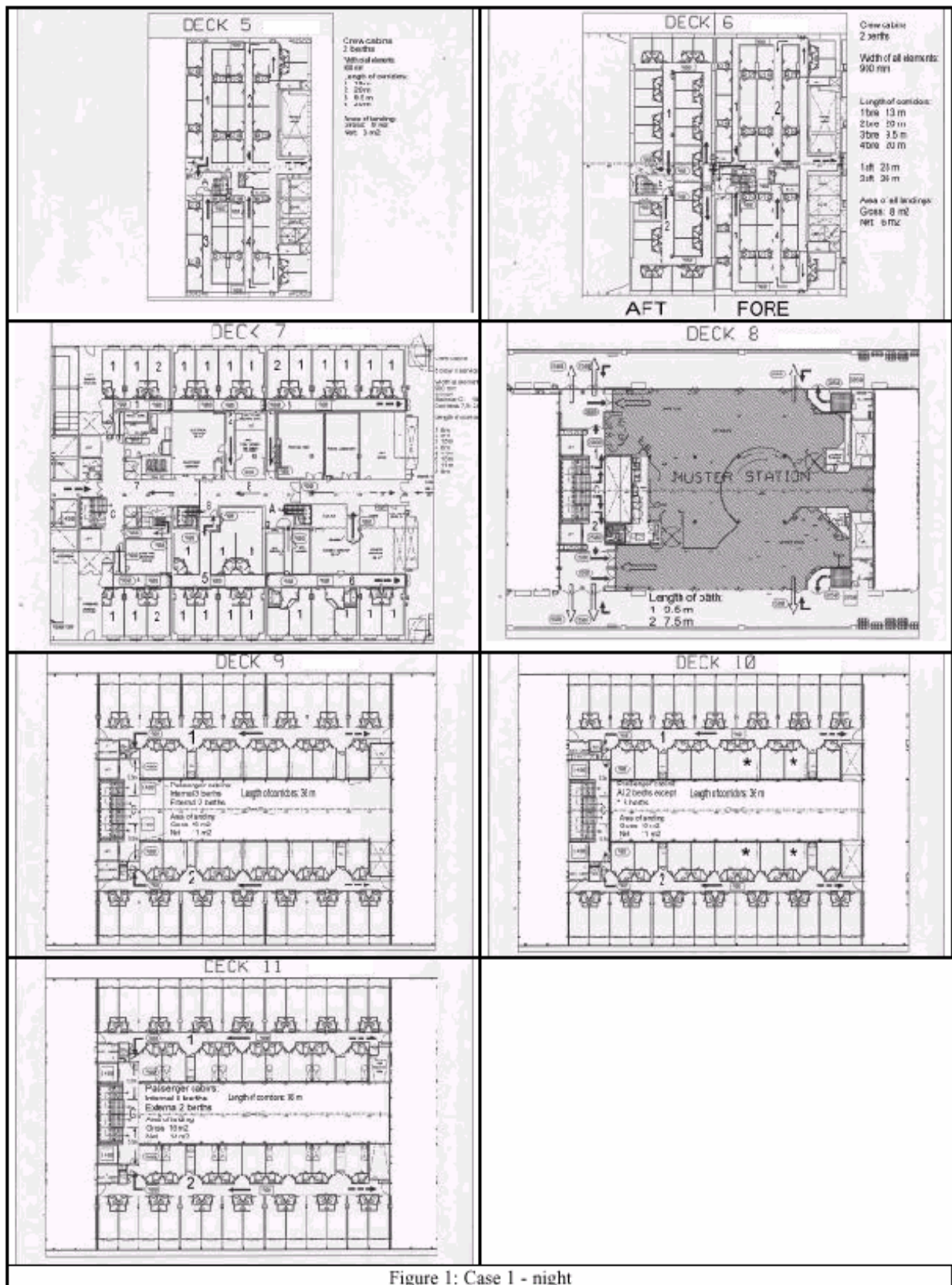

Figure 1: Case 1 - night

NOTE: "Muster Station" has the same meaning as "Assembly Station".

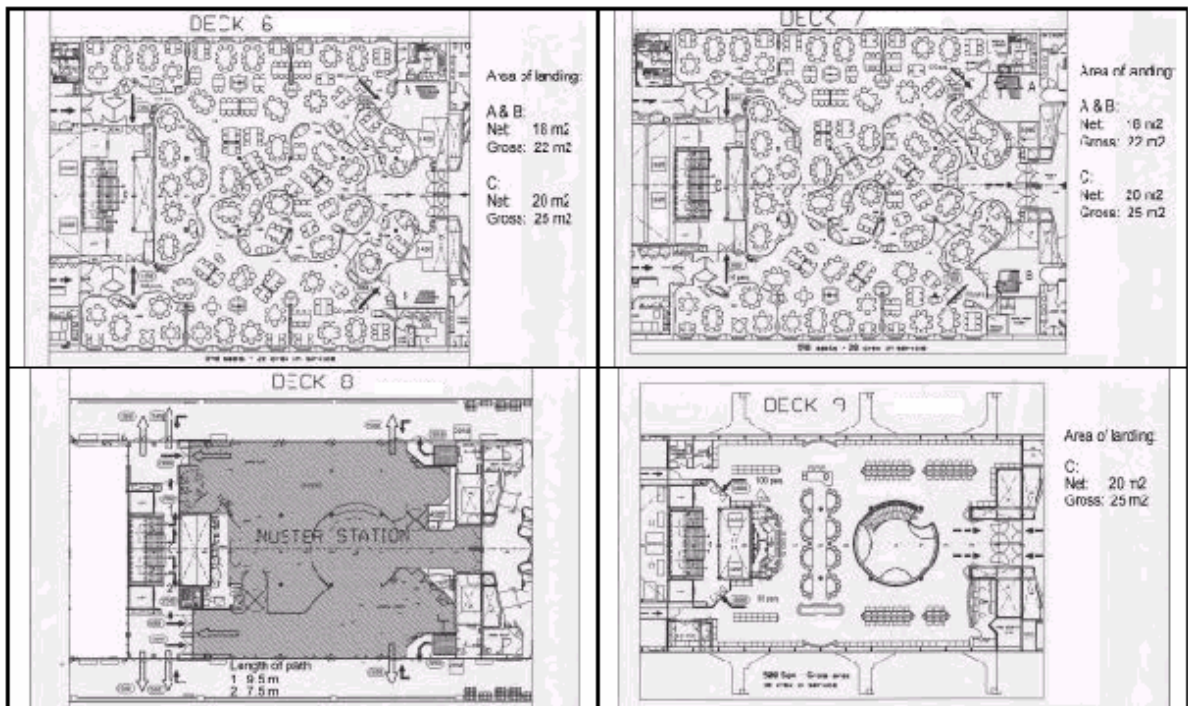

Figure 2: Case 2 - day

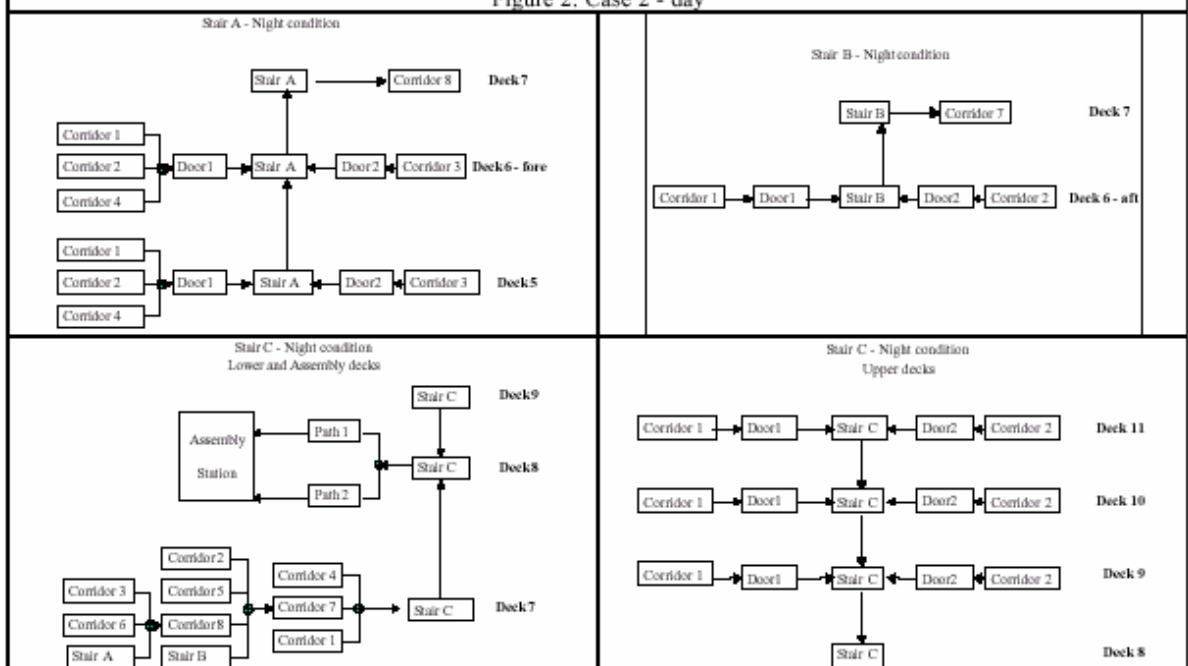

Figure 3: Case 1 (night) – hydraulic network schematisation

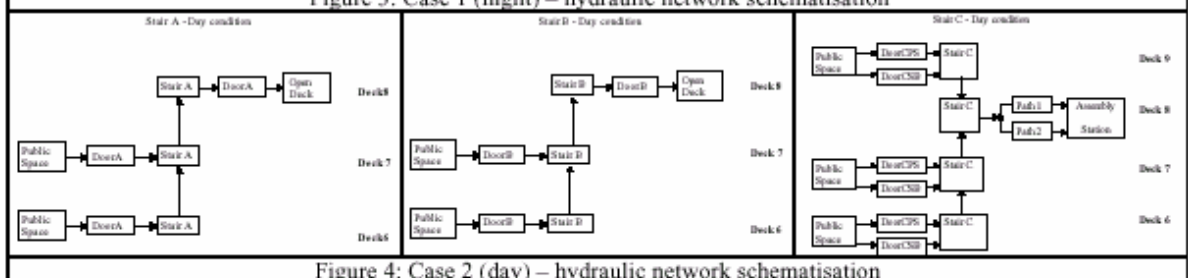

Figure 4: Case 2 (day) – hydraulic network schematisation

NOTE: “Muster Station” has the same meaning as “Assembly Station”.

4 Scenarios considered

4.1 Case 1 refers to a day scenario in MVZ 1, according to chapter 13 of the FSS Code, the 449 persons are initially distributed as follows: 42 in deck 5; 65 in deck 6 (42 in the fore part and 23 in the aft part); 26 in deck 7; 110 in deck 9; 96 in deck 10; and 110 in deck 11. Deck 8 (assembly station) is empty. In accordance with paragraph 2.2 of appendix 1 to the Guidelines, all persons in the cabins are assumed to simultaneously move into the corridors. The corresponding initial conditions are:

MVZ 1 - Corridors	Persons	Initial density D (p/m²)	Initial specific flow Fs (p/(ms))	Calculated flow Fc (p/s)	Initial speed of persons S (m/s)
Deck 5 – corridor 1	11	0.94	0.85	0.77	1.03
Deck 5 – corridor 2	12	0.67	0.73	0.65	1.14
Deck 5 – corridor 3	8	0.94	0.85	0.77	1.04
Deck 5 – corridor 4	11	0.61	0.7	0.63	1.16
Deck 6 – corridor 1	11	0.94	0.85	0.77	1.03
Deck 6 – corridor 2	12	0.67	0.73	0.65	1.14
Deck 6 – corridor 3	8	0.94	0.85	0.77	1.04
Deck 6 – corridor 4	11	0.61	0.7	0.63	1.16
Deck 6 – corridor 5	11	0.94	0.85	0.77	1.03
Deck 6 – corridor 6	12	0.67	0.73	0.65	1.14
Deck 7 – corridor 1	4	0.74	0.76	0.69	1.11
Deck 7 – corridor 2	4	0.49	0.64	0.58	1.2
Deck 7 – corridor 3	6	0.44	0.58	0.52	1.2
Deck 7 – corridor 4	4	0.74	0.76	0.69	1.11
Deck 7 – corridor 5	6	0.48	0.62	0.56	1.2
Deck 7 – corridor 6	2	0.15	0.19	0.17	1.2
Deck 7 – corridor 7	0	0	N.A.	N.A.	N.A.
Deck 7 – corridor 8	0	0	N.A.	N.A.	N.A.
Deck 11 – corridor 1	55	1.7	1.21	1.09	0.75
Deck 11 – corridor 2	55	1.7	1.21	1.09	0.75
Deck 10 – corridor 1	48	1.48	1.11	1	0.83
Deck 10 – corridor 2	48	1.48	1.11	1	0.83
Deck 9 – corridor 1	55	1.7	1.21	1.09	0.74
Deck 9 – corridor 2	55	1.7	1.21	1.09	0.74

MVZ 1 – Stairs, doors & corridors	Persons (N)		Specific flow Fs in (p/(ms))	Max. specific flow Fs (p/(ms))	Specific flow Fs (p/(ms))	Cal- culated flow Fc (p/s)	Speed of persons S (m/s)	Queue	Comments	Notes
	From current route	Total including those from other routes								
Deck 5 – door 1	34	34	2.28	1.3	1.3	1.17	N.A.	Yes	From corridors 1, 2 and 4	1
Deck 5 – door 2	8	8	1.85	1.3	0.85	0.77	N.A.		From corridor 3	1
Deck 5 – stair A	42	42	1.43	0.88	0.88	1.188	0.44	Yes	From doors 1 and 2	1, 2
Deck 6 – door 1	34	34	2.58	1.30	1.3	1.17	N.A.	Yes	From corridors 1, 2, and 4;	1
Deck 6 – door 2	8	8	0.85	1.30	0.85	0.77	N.A.		From corridor 3	1
Deck 6 – stair A	42	84	2.32	0.88	0.88	1.188	0.44	Yes	From doors 1 and 2, from deck 5	1, 2
Deck 6 – door 3	11	11	0.85	1.30	0.85	0.77	N.A.		From corridor 5	1
Deck 6 – door 4	12	12	0.73	1.30	0.81	0.73	N.A.		From corridor 4	1
Deck 6 – stair B	23	23	1.05	0.88	0.88	1.188	0.44	Yes	From doors 3 and 4	1, 2
Deck 7 – corridor 8	8	92	0.78	1.3	0.78	1.88	1.09		From corridors 3 and 6, from deck 6, stair A	1, 3
Deck 7 – corridor 7	18	125	1.75	1.3	1.3	3.12	0.67	Yes	From corridors 2, 5 and 8, from deck 6, stair B	1, 4
Deck 7 – stair C	8	133	3.21	0.88	0.88	1.232	0.44	Yes	From corridors 1, 4 and 7; up to deck 8	1, 2, 5
Deck 11 – door 1	55	55	1.21	1.3	1.21	1.09	N.A.		To stair C	1
Deck 11 – door 2	55	55	1.21	1.3	1.21	1.09	N.A.		To stair C	1
Deck 11 – stair C	110	110	0.78	1.1	0.78	2.17	0.81		Down to deck 10	1, 2
Deck 10 – door 1	48	48	1.11	1.3	1.11	1	N.A.		To stair C	1
Deck 10 – door 2	48	48	1.11	1.3	1.11	1	N.A.		To stair C	1
Deck 10 – stair C	96	206	1.49	1.1	1.10	3.08	0.55	Yes	Down to deck 9	1, 2
Deck 9 – door 1	55	55	1.21	1.3	1.21	1.09	N.A.		To stair C	1
Deck 9 – door 2	55	55	1.21	1.3	1.21	1.09	N.A.		To stair C	1
Deck 9 – stair C	110	316	1.88	1.1	1.10	3.08	0.55	Yes	Down to deck 8	1, 2
Deck 8 – path 1	0	200	0.96	1.3	0.96	1.92	0.95		To assembly stat	1, 6
Deck 8 – path 2	0	249	0.96	1.3	0.96	2.4	0.95		To assembly stat	1, 6

Notes:

- 1 The specific flow “Fs in” is the specific flow entering the element of the escape route; the maximum specific flow is the maximum allowable flow given in table 1.3 of appendix 1 of the Guidelines; the specific flow is the one applicable for the calculations i.e., the minimum between “Fs in” and the maximum allowable; when “Fs in” is greater than the maximum allowable, a queue is formed.
- 2 Some stairs are used by both persons coming from below (or above) and persons coming from the current deck considered; in making the calculation for a stair connecting deck N to deck N+1 (or deck N-1), the persons to be considered are those entering the stairs at deck N plus those coming from all decks below (or above) deck N.
- 3 At deck 7, 8 persons initially move from the cabins into corridor 8 and 84 persons arrive to corridor 8 from deck 6, stair A; the total is therefore 92 persons.
- 4 At deck 7, 18 persons initially move from the cabins into corridor 7, 23 persons arrive to corridor 7 from deck 6 stair B and 84 persons arrive to corridor 8 from deck 7, corridor 7; the total is therefore 125 persons.
- 5 At deck 7, 8 persons initially move from the cabins directly to the stair C and 125 persons arrive to stair C from corridor 8; the total is therefore 133 persons.
- 6 At deck 8 (assembly/muster station), no persons are initially present, therefore the escape routes on this deck are then used by the total number of persons arriving from above and/or below.

4.2 Case 2 refers to a day scenario in MVZ 2, according to chapter 13 of the FSS Code, the 1,138 persons are initially distributed as follows: 469 in deck 6; 469 in deck 7; and 200 in deck 9. Deck 8 (assembly/muster station) is initially empty. In accordance with paragraph 2.2 of appendix 1 to the Guidelines, all persons are assumed to simultaneously begin the evacuation and use the exit doors at their maximum specific flow. The corresponding initial conditions are:

MVZ 2 - Doors	Persons	Initial density D (p/m²)	Initial Specific flow Fs (p/(ms))	Calculated flow Fc (p/s)	Initial speed of persons S (m/s)
Deck 6 – door A	100	N.A.	1.3	1.3	N.A.
Deck 6 – door B	100	N.A.	1.3	1.3	N.A.
Deck 6 – door C PS	134	N.A.	1.3	1.76	N.A.
Deck 6 – door C SB	135	N.A.	1.3	1.76	N.A.
Deck 7 – door A	170	N.A.	1.3	2.21	N.A.
Deck 7 – door B	170	N.A.	1.3	2.21	N.A.
Deck 7 – door C PS	65	N.A.	1.3	1.17	N.A.
Deck 7 – door C SB	64	N.A.	1.3	1.17	N.A.
Deck 9 – door C SB	100	N.A.	1.3	1.3	N.A.
Deck 9 – door C PS	100	N.A.	1.3	1.3	N.A.

MVZ 2 - Stairs	Persons (N)		Specific flow Fs in (p/(ms))	Max. specific flow Fs (p/(ms))	Specific flow Fs (p/(ms))	Calculated flow Fc (p/s)	Speed of persons S (m/s)	Queue	Comments	Notes
	From current route	Total including those from other routes								
Deck 6 – stair A	100	100	0.93	0.88	0.88	1.23	0.44	Yes	up to deck 7	1
Deck 6 – stair B	100	100	0.93	0.88	0.88	1.23	0.44	Yes	up to deck 7	1
Deck 6 – stair C	269	269	1.1	0.88	0.88	2.82	0.44	Yes	up to deck 7	1
Deck 7 – stair A	170	270	1.68	0.88	0.88	1.8	0.44	Yes	up to deck 8	1, 2
Deck 7 – stair B	170	270	1.68	0.88	0.88	1.8	0.44	Yes	up to deck 8	1, 2
Deck 7 – stair C	129	398	1.61	0.88	0.88	2.82	0.44	Yes	up to deck 8	1, 2
Deck 9 – stair C	200	200	0.81	1.1	0.81	2.60	0.78		down to deck 8	
Deck 8 – path 1	0	266	1.2	1.3	1.2	2.41	0.75		from decks 7 and 9	1, 3
Deck 8 – path 2	0	332	1.2	1.3	1.2	3.01	0.75		from decks 7 and 9	1, 3
Deck 8 – door A	0	270	0.88	1.3	0.88	1.8	N.A.		from deck 7	1, 3
Deck 8 – door B	0	270	0.88	1.3	0.88	1.8	N.A.		from deck 7	1, 3

Notes:

- 1 The specific flow “Fs in” is the specific flow entering the element of the escape route; the maximum specific flow is the maximum allowable flow given in table 1.3 of appendix 1 of the Guidelines; the specific flow is the one applicable for the calculations i.e., the minimum between “Fs in” and the maximum allowable; when “Fs in” is greater than the maximum allowable, a queue is formed.
- 2 Some stairs are used by both persons coming from below (or above) and persons coming from the current deck considered; in making the calculation for a stair connecting deck N to deck N+1 (or deck N-1), the persons to be considered are those entering the stairs at deck N plus those coming from all decks below (or above) deck N.
- 3 At deck 8 (assembly/muster station), no persons are initially present, therefore the escape routes on this deck are then used by the total number of persons arriving from above and/or below.

5 Calculation of t_F , t_{deck} and t_{stair}

5.1 For case 1:

Item	Persons N	Length L (m)	Calculated flow F_c (p/s)	Speed S (m/s)	Flow time t_F (s) $t_F = N / F_c$	Deck or stairs time, t_{deck}, t_{stairs} $T = L/S$	Entering
Deck 5 – corridor 1	11	13	0.77	1.03	14.3	12.6	Door 1
Deck 5 – corridor 2	12	20	0.65	1.14	18.3	17.6	Door 1
Deck 5 – corridor 3	8	9.5	0.77	1.04	10.4	9.2	Door 2
Deck 5 – corridor 4	11	20	0.63	1.16	17.4	17.3	Door 1
Deck 5 – door 1	34	N.A.	1.17	N.A.	29.1	N.A.	Stair A
Deck 5 – door 2	8	N.A.	0.77	N.A.	10.4	N.A.	Stair A
Deck 5 – stair A	42	4.67	1.188	0.44	35.4	10.6	Deck 6
Deck 6 – corridor 1	11	13	0.77	1.03	14.3	12.6	Door 1
Deck 6 – corridor 2	12	20	0.65	1.14	18.3	17.6	Door 1
Deck 6 – corridor 3	8	9.5	0.77	1.04	10.4	9.2	Door 2
Deck 6 – corridor 4	11	20	0.63	1.16	17.4	17.3	Door 1
Deck 6 – door 1	34	N.A.	1.17	N.A.	29.1	N.A.	Stair A
Deck 6 – door 2	8	N.A.	0.77	N.A.	10.4	N.A.	Stair A
Deck 6 – stair A	84	4.67	1.188	0.44	70.7	10.6	Deck 7
Deck 6 – corridor 5	11	13	0.77	1.03	14.3	12.6	Door 3
Deck 6 – corridor 6	12	20	0.65	1.14	18.3	17.6	Door 4
Deck 6 – door 3	11	N.A.	0.77	N.A.	14.3	N.A.	Stair B
Deck 6 – door 4	12	N.A.	0.65	N.A.	18.3	N.A.	Stair B
Deck 6 – stair B	23	4.67	1.188	0.44	19.4	10.6	Deck 7
Deck 7 – corridor 1	4	6	0.69	1.11	5.8	5.4	Stair C
Deck 7 – corridor 2	4	9	0.58	1.2	6.9	7.5	Corridor 7
Deck 7 – corridor 3	6	15	0.52	1.2	11.5	12.5	Corridor 8
Deck 7 – corridor 4	4	6	0.69	1.11	5.8	5.4	Stair C
Deck 7 – corridor 5	6	14	0.56	1.2	10.8	11.7	Corridor 7
Deck 7 – corridor 6	2	15	0.17	1.2	11.5	12.5	Corridor 8
Deck 7 – corridor 8	92	9	1.88	1.09	48.9	8.2	Corridor 7
Deck 7 – corridor 7	125	11	3.12	0.67	40.1	16.4	Stair C
Deck 7 – stair C	133	4.67	1.232	0.44	108	10.6	Deck 8
Deck 11– corridor 1	55	36	1.09	0.75	50.7	48.2	Door 1
Deck 11– corridor 2	55	36	1.09	0.75	50.7	48.2	Door 2
Deck 11 – door 1	55	N.A.	1.09	N.A.	50.7	N.A.	Stair C
Deck 11 – door 2	55	N.A.	1.09	N.A.	50.7	N.A.	Stair C
Deck 11 – stair C	110	4.67	2.17	0.81	50.7	5.8	Deck 10
Deck 10– corridor 1	48	36	1	0.83	48.2	43.5	Door 1
Deck 10– corridor 2	48	36	1	0.83	48.2	43.5	Door 2
Deck 10 – door 1	48	N.A.	1	N.A.	48.2	N.A.	Stair C
Deck 10 – door 2	48	N.A.	1	N.A.	48.2	N.A.	Stair C
Deck 10 – stair C	206	4.67	3.08	0.55	66.9	8.5	Deck 9
Deck 9 – corridor 1	55	36	1.09	0.74	50.7	48.4	Door 1
Deck 9 – corridor 2	55	36	1.09	0.74	50.7	48.4	Door 2
Deck 9 – door 1	55	N.A.	1.09	N.A.	50.7	N.A.	Stair C
Deck 9 – door 2	55	N.A.	1.09	N.A.	50.7	N.A.	Stair C
Deck 9 – stair C	316	4.67	3.08	0.55	102.6	8.5	Deck 8

5.2 For case 2: since in this particular arrangement there are no corridors, the deck time is zero.

Item	Persons <i>N</i>	Length <i>L</i> (m)	Calculated flow <i>Fc</i> (p/s)	Speed <i>S</i> (m/s)	Flow time <i>t_F</i> (s) <i>t_F = N/ Fc</i>	Deck or stairs time, <i>t_{deck}</i> , <i>t_{stairs}</i> <i>t = L/S</i>	Entering
Deck 6 – door A	100	N.A.	1.3	N.A.	76.9	N.A.	Stair A
Deck 6 – door B	100	N.A.	1.3	N.A.	76.9	N.A.	Stair B
Deck 6 – door C PS	134	N.A.	1.76	N.A.	76.4	N.A.	Stair C
Deck 6 – door C SB	135	N.A.	1.76	N.A.	76.9	N.A.	Stair C
Deck 6 – stair A	100	4.67	1.23	0.44	81.2	10.6	Deck 7
Deck 6 – stair B	100	4.67	1.23	0.44	81.2	10.6	Deck 7
Deck 6 – stair C	269	4.67	2.82	0.44	95.5	10.6	Deck 7
Deck 7 – door A	170	N.A.	2.21	N.A.	76.9	N.A.	Stair A
Deck 7 – door B	170	N.A.	2.21	N.A.	76.9	N.A.	Stair B
Deck 7 – door C PS	65	N.A.	1.17	N.A.	55.6	N.A.	Stair C
Deck 7 – door C SB	64	N.A.	1.17	N.A.	54.7	N.A.	Stair C
Deck 7 – stair A	270	4.67	1.8	0.44	149.7	10.6	Deck 8
Deck 7 – stair B	270	4.67	1.8	0.44	149.7	10.6	Deck 8
Deck 7 – stair C	398	4.67	2.82	0.44	141.3	10.6	Deck 8
Deck 8 – door A	270	N.A.	1.8	N.A.	149.7	N.A.	Embarkation
Deck 8 – door B	270	N.A.	1.8	N.A.	149.7	N.A.	Embarkation
Deck 9 – door PS	100	N.A.	1.3	N.A.	76.9	N.A.	Stair C
Deck 9 – door SB	100	N.A.	1.3	N.A.	76.9	N.A.	Stair C
Deck 9 – stair C	200	4.67	2.6	0.78	76.9	6	Deck 8

6 Calculation of $t_{assembly}$

6.1 Case 1: In this case, all the 429 persons use stair C (316 coming from above deck 8 and 133 from below) and, once arrived at deck 8, need to travel on deck 8 to reach the assembly station using either path 1 or path 2. The corresponding time is as follows:

Item	Persons <i>N</i>	Length <i>L</i> (m)	Calculated flow <i>Fc</i> (p/s)	Speed <i>S</i> (m/s)	Flow time <i>t_F</i> (s) <i>t_F = N/ Fc</i>	$t_{assembly}$ <i>t = L/S</i>	Entering
Deck 8 – path 1	200	9.5	1.92	0.95	104.4	10	Assembly station
Deck 8 – path 2	249	7.5	2.4	0.95	103.9	7.9	Assembly station

6.2 Case 2: In this case, all the persons using stair C (totalling 598), once arrived at deck 8, need to travel through on deck 8 to reach the assembly station using either path 1 or path 2. The corresponding time is as follows:

Item	Persons N	Length L (m)	Calculated flow F_c (p/s)	Speed S (m/s)	Flow time t_F (s) $t_F = N / F_c$	$t_{assembly}$ $t = L/S$	Entering
Deck 8 – path 1	266	9.5	2.41	0.75	110.5	12.7	Assembly station
Deck 8 – path 2	332	7.5	3.01	0.75	110.3	10	Assembly station

7 Calculation of T

7.1 Case 1: The travel time T , according to appendix 1 to the Interim Guidelines, is the maximum t_I (equation 2.2.11) multiplied by 2.3 (sum of correction factor and counterflow correction factor). The maximum values of t_I for each escape route are given in the following:

Escape route on	T_{deck}	t_f	t_{stair}	$t_{assembly}$	t_I	T	Notes
Deck 11	48.2	104.4	22.7	10	185.3	426.2	1
Deck 10	43.5	104.4	17	10	174.8	402	1, 2
Deck 9	48.4	104.4	8.5	10	171.3	394	1, 2
Deck 8	0	104.4	0	10	114.4	286.1	
Deck 7	37.1	108	10.6	10	163.9	377	1
Deck 6 – stair A (fore)	42.4	108	21.2	10	179.6	413.1	1, 3
Deck 6 – stair B (aft)	34	108	21.2	10	170.2	391.5	1, 3
Deck 5	42.2	108	31.8	10	190.2	437.5	1, 3

Notes:

- 1 The flow time, t_f , is the maximum flow time recorded on the whole escape route from the deck where persons started evacuating up to the muster station.
- 2 The travel time on the stairways (t_{stair}) is the total time necessary to travel along all the stairs from the deck where persons originally started evacuating up to the deck where the assembly station is located; in the present case, t_{stair} for persons moving down from deck 11 is therefore the sum of t_{stair} from deck 11 to 10 (5.7 s), from deck 10 to 9 (8.5 s) and from deck 9 to 8 (8.5 s), in total 22.7 s; similarly for the other cases.
- 3 The travel time on the stairways (t_{stair}) is the total time necessary to travel along all the stairs from the deck where persons originally started evacuating up to the deck where the assembly station is located; in the present case, t_{stair} for persons moving up from deck 5 is therefore the sum of t_{stair} from deck 5 to 6 (10.6 s.), from deck 6 to 7 (10.6 s) and from deck 7 to 8 (10.6 s), in total 31.8 s; similarly for the other cases.

Accordingly, the corresponding value of T is 437.5 s.

7.2 Case 2: The travel time T , according to appendix 1 to the Guidelines, is the maximum t_I equation 2.2.11) multiplied by 2.3 (sum of correction factor and counterflow correction factor). The maximum values of t_I for each escape route are given in the following:

Escape route on	T_{deck}	t_f	t_{stair}	$t_{assembly}$	t_I	T	Notes
Deck 9	0	110.4	6	12.7	168.3	387.2	1, 2
Deck 8	0	110.4	0	12.7	162.4	373.4	
Deck 7 – stair A	0	149.7	10.6	0	160.3	368.6	
Deck 7 – stair B	0	149.7	10.6	0	160.3	368.6	
Deck 7 – stair C	0	141.3	10.6	12.7	164.6	378.7	2
Deck 6 – stair A	0	149.7	21.2	0	170.9	393	1, 3
Deck 6 – stair B	0	149.7	21.2	0	170.9	393	1, 3
Deck 6 – stair C	0	141.3	21.2	12.7	175.2	403.1	1, 2, 3

Notes:

- 1 The flow time, t_f , is the maximum flow time recorded on the whole escape route from the deck where persons started evacuating up to the assembly station.
- 2 In this example, stairs A and B are already leading to the embarkation station, therefore only those escape routes passing through stair C need additional time, $t_{assembly}$, to reach the assembly station.
- 3 The travel time on the stairways (t_{stair}) is the total time necessary to travel along all the stairs from the deck where persons originally started evacuating up to the deck where the assembly station is located; in the present case, t_{stair} for persons moving from deck 6 is therefore the sum of t_{stair} from deck 6 to 7 (10.6 s) and from deck 7 to 8 (10.6 s).

Accordingly, the corresponding value of T is 403.1 s.

8 Identification of congestion

8.1 Case 1: Congestion takes place on deck 5 (door 1 and stair A), deck 6 (door 1, stairs A and B), deck 7 (corridor 7 and stair C), deck 10 (stair C) and deck 9 (stair C). However, since the total time is below the limit (see paragraph 9.1 of this example) and no design modifications are needed.

8.2 Case 2: Congestion takes place on deck 6 (stairs A, B and C) and deck 7 (stairs A, B and C). However, since the total time is below the limit (see paragraph 9.2 of this example) no design modifications are needed.

9 Performance standard

9.1 Case 1: The total evacuation time, according to paragraph 3.5 of the Interim Guidelines is as follows:

$$1.25 A + T + 2/3 (E+L) = 1.25 \cdot x (10' + 7'18'') + 20 = 41' 38'' \quad (9.1)$$

where:

$E + L$ is assumed to be 30'

$A = 10'$ (night case)

$T = 7' 18''$

9.2 Case 2: The total evacuation time, according to paragraph 3.5 of the Interim Guidelines is as follows:

$$1.25A + T + 2/3 (E+L) = 1.25 \times (5' + 6' 43'') + 20 = 34' 39'' \quad (9.2)$$

where:

$E + L$ is assumed to be 30'

$A = 5'$ (day case)

$T = 6' 43''$.

ANNEX 2

**GUIDELINES FOR AN ADVANCED EVACUATION ANALYSIS
OF NEW AND EXISTING PASSENGER SHIPS*****1 General**

1.1 The purpose of these Guidelines is to present the methodology for conducting an advanced evacuation analysis and, in particular, to:

- .1 identify and eliminate, as far as practicable, congestion which may develop during an abandonment, due to normal movement of passengers and crew along escape routes, taking into account the possibility that crew may need to move along these routes in a direction opposite the movement of passengers; and
- .2 demonstrate that escape arrangements are sufficiently flexible to provide for the possibility that certain escape routes, assembly stations, embarkation stations or survival craft may be unavailable as a result of a casualty.

2 Definitions

2.1 *Person load* is the number of persons (p) considered in the means of escape calculations contained in chapter 13 of the Fire Safety Systems (FSS) Code (resolution MSC.98(73)).

2.2 *Response times* are intended to reflect the total time spent in pre-evacuation movement activities beginning with the sound of the alarm. This includes issues such as cue perception provision and interpretation of instructions, individual reaction times, and performance of all other miscellaneous pre-evacuation activities.

2.3 *Individual travel time* is the time incurred by an individual in moving from his/her starting location to reach the assembly station.

2.4 *Individual assembly time* is the sum of the individual response time and the individual travel time.

2.5 *Total assembly time* (t_A), is the maximum individual assembly time.

2.6 *Embarkation time* (E) and *launching time* (L), the sum of which defines the time required to provide for abandonment by the total number of persons on board.

* **Note:** Advanced evacuation analysis is taken to mean a computer-based simulation that represents each occupant as an individual that has a detailed representation of the layout of a ship and represents the interaction between the occupants and the layout.

3 Method of evaluation

3.1 *Description of the system:*

- .1 Identification of assembly stations.
- .2 Identification of escape routes.

3.2 *Assumptions*

This method of estimating the evacuation time is based on several idealized benchmark scenarios and the following assumptions are made:

- .1 the passengers and crew are represented as unique individuals with specified individual abilities and response times;
- .2 passengers and crew will evacuate via the main escape routes, as referred to in SOLAS regulation II-2/13;
- .3 passenger load and initial distribution is based on chapter 13 of the FSS Code;
- .4 unless otherwise stated, full availability of escape arrangements is considered;
- .5 a safety factor having a value of 1.25 is introduced in the calculation to take account of model omissions, assumptions, and the limited number and nature of the benchmark scenarios considered. These issues include:
 - .5.1 the crew will immediately be at the evacuation duty stations ready to assist the passengers;
 - .5.2 passengers follow the signage system and crew instructions (i.e., route selection is not predicted by the analysis);
 - .5.3 smoke, heat and toxic fire products present in fire effluent are not considered to impact passenger/crew performance;
 - .5.4 family group behaviour is not considered in the analysis; and
 - .5.5 ship motion, heel, and trim are not considered.

3.3 *Scenarios to be considered*

3.3.1 As a minimum, four scenarios should be considered for the analysis. Two scenarios, namely night (case 1) and day (case 2), as specified in chapter 13 of the FSS Code; and two further scenarios (case 3 and case 4) based on reduced escape route availability are considered for the day and night case, as specified in the appendix.

3.3.2 Additional relevant scenarios may be considered as appropriate.

3.4 Calculation of the evacuation time

The following components should be included in the calculation of the evacuation time as specified in paragraphs 3.5 and 3.6 below:

- .1 The response time distribution to be used in the calculations is specified in the appendix.
- .2 The method to determine the travel time, T is given in the appendix.
- .3 Embarkation time (E) and launching time (L).

3.5 Performance standards

3.5.1 The following performance standards, as illustrated in figure 3.5.3, should be complied with:

$$\text{Calculated total evacuation time: } 1.25 T + 2/3 (E + L) \leq n \quad (1)$$

$$E + L \leq 30 \text{ min} \quad (2)$$

3.5.2 In performance standard (1):

- .1 for ro-ro passenger ships, $n = 60$; and
- .2 for passenger ships other than ro-ro passenger ships, $n = 60$ for ships with no more than three main vertical zones and $n = 80$ for ships with more than three main vertical zones.

3.5.3 Performance standard (2) complies with SOLAS regulation III/21.1.4.

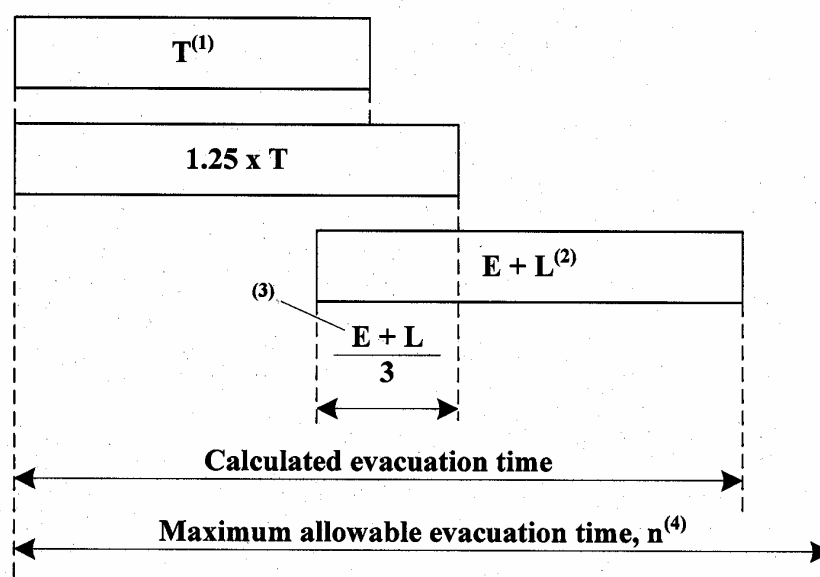

- (1) calculated as in the appendix to the Interim Guidelines
- (2) maximum 30 min in compliance with SOLAS regulation III/21.1.4
- (3) overlap time = $1/3 (E+L)$
- (4) values of n (min) provided in paragraph 3.5.2

Figure 3.5.3

3.6 *Calculation of E + L*

3.6.1 *E + L* should be calculated based upon:

- .1 the results of full scale trials on similar ships and evacuation systems; or
- .2 data provided by the manufacturers. However, in this case, the method of calculation should be documented, including the value of safety factor used.

3.6.2 For cases where neither of the two above methods can be used, *E + L* should be assumed equal to 30 min.

3.7 *Identification of congestion*

3.7.1 Congestion within regions is identified by local population densities exceeding 4 p/m² for significant periods of time. These levels of congestion may or may not be significant to the overall assembly process.

3.7.2 If any identified congestion region is found to persist for longer than 10% of the simulated overall assembly time (t_A), it is considered to be significant.

4 **Corrective actions**

4.1 For new ships, if the total evacuation time calculated, as described in paragraph 3.5 above, is in excess of the required total evacuation time, corrective actions should be considered at the design stage by suitably modifying the arrangements affecting the evacuation system in order to reach the required total evacuation time.

4.2 For existing ships, if the total evacuation time calculated, as described in paragraph 3.5 above, is in excess of the total evacuation time, on-board evacuation procedures should be reviewed with a view toward taking appropriate actions which would reduce congestion which may be experienced in locations as indicated by the analysis.

5 **Documentation**

The documentation of the analysis should be provided as specified in the appendix.

APPENDIX

METHOD TO DETERMINE THE TRAVEL TIME (T) BY SIMULATION TOOLS FOR THE ADVANCED EVACUATION ANALYSIS

1 Characteristics of the models

- 1.1 Each person (p) is represented in the model individually.
- 1.2 The abilities of each person are determined by a set of parameters, some of which are probabilistic.
- 1.3 The movement of each person is recorded.
- 1.4 The parameters should vary among the individuals of the population.
- 1.5 The basic rules for personal decisions and movements are the same for everyone, described by a universal algorithm.
- 1.6 The time difference between the actions of any two persons in the simulation should be not more than one second of simulated time, e.g. all persons proceed with their action in one second (a parallel update is necessary).

2 Parameters to be used

- 2.1 In order to facilitate their use, the parameters are grouped into the same 4 categories as used in other industrial fields, namely: GEOMETRICAL, POPULATION, ENVIRONMENTAL and PROCEDURAL.
- 2.2 Category GEOMETRICAL: layout of escape routes, their obstruction and partial unavailability, initial passenger and crew distribution conditions.
- 2.3 Category POPULATION: ranges of parameters of persons and population demographics.
- 2.4 Category ENVIRONMENTAL: static and dynamic conditions of the ship.
- 2.5 Category PROCEDURAL: crew members available to assist in emergency.

3 Recommended values of the parameters

3.1 *Category GEOMETRICAL*

3.1.1 General. The evacuation analysis specified in this annex is aimed at measuring the performance of the ship in reproducing benchmark scenarios rather than simulating an actual emergency situation. Four benchmark cases should be considered, namely cases 1, 2, 3 and 4 (refer to paragraph 4 for detailed specifications) corresponding to primary evacuation cases (cases 1 and 2, where all the escape routes should be assumed to be in operation) and secondary evacuation cases (cases 3 and 4, where some of the escape route should be assumed to be unavailable).

3.1.2 Layout of escape routes - primary evacuation cases (case 1 and case 2): Passengers and crew should be assumed to proceed along the primary escape routes and to know their ways up to the assembly stations; to this effect, signage, low-location lighting, crew training and other relevant aspects connected with the evacuation system design and operation should be assumed to be in compliance with the requirements set out in IMO instruments.

3.1.3 Layout of escape routes – secondary evacuation cases (case 3 and case 4): Those passengers and crew who were previously assigned to the now unavailable primary escape route should be assumed to proceed along the escape routes determined by the ship designer.

3.1.4 Initial passenger and crew distribution condition. The occupant distribution should be based upon the cases defined in chapter 13 of the FSS Code, as outlined in 4.

3.2 *Category POPULATION*

3.2.1 This describes the make-up of the population in terms of age, gender, physical attributes and response times. The population is identical for all scenarios with the exception of the response time and passenger initial locations. The population is made of the following mix:

Table 3.1 – Population’s composition (age and gender)

Population groups - passengers	Percentage of passengers (%)
Females younger than 30 years	7
Females 30-50 years old	7
Females older than 50 years	16
Females older than 50, mobility impaired (1)	10
Females older than 50, mobility impaired (2)	10
Males younger than 30 years	7
Males 30-50 years old	7
Males older than 50 years	16
Males older than 50, mobility impaired (1)	10
Males older than 50, mobility impaired (2)	10
Population groups – crew	Percentage of crew (%)
Crew females	50
Crew males	50

All of the attributes associated with this population distribution should consist of a statistical distribution within a fixed range of values. The range is specified between a minimum and maximum value with a uniform random distribution.

3.2.2 **Response time**

The response time distributions for the benchmark scenarios should be truncated logarithmic normal distributions¹ as follows:

¹ “Recommendations on the Nature of the Passenger Response Time Distribution to be used in the MSC.1033 Assembly Time Analysis Based on Data Derived from Sea Trials”, Galea, E. R., Deere, S., Sharp, G., Fillips, L., Lawrence, P., and Gwunne, S., The Transaction of The Royal Institution of Naval Architects, Part A - International Journal of Maritime Engineering ISSN 14798751.2007.

For Case 1 and Case 3 (Night Cases):

$$y = \frac{1.01875}{\sqrt{2\pi} 0.84 (x - 400)} \exp \left[-\frac{(\ln(x - 400) - 3.95)^2}{2 \times 0.84^2} \right] \quad (3.2.2.1)$$

$$400 < x < 700$$

For Case 2 and Case 4 (Day Cases):

$$y = \frac{1.00808}{\sqrt{2\pi} 0.94x} \exp \left[-\frac{(\ln(x) - 3.44)^2}{2 \times 0.94^2} \right] \quad (3.2.2.2)$$

$$0 < x < 300$$

where, x is the response time in seconds and y is the probability density at response time x .

3.2.3 Unhindered travel speeds on flat terrain (e.g., corridors)

The maximum unhindered travel speeds to be used are those derived from data published by Ando² which provides male and female walk rates as a function of age. These are distributed according to figure 3.1 and represented by approximate piecewise functions shown in table 3.3.

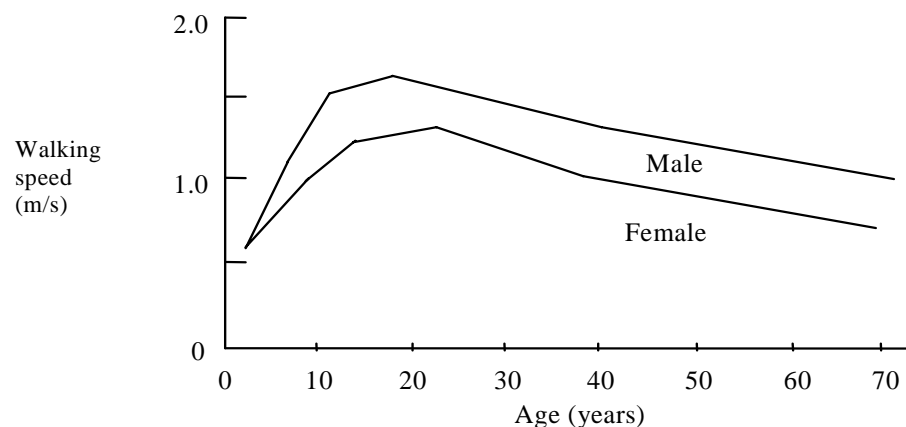

Figure 3.1 - Walking speeds as a function of age and gender

² Ando K, Ota H, and Oki T, Forecasting The Flow Of People, Railway Research Review, (45), pp 8-14, 1988.

Table 3.3 - Regression formulation for mean travel speed values³

Gender	Age (years)	Speed (m/s)
Female	2 - 8.3	$0.06 * \text{age} + 0.5$
	8.3 - 13.3	$0.04 * \text{age} + 0.67$
	13.3 - 22.25	$0.02 * \text{age} + 0.94$
	22.25 - 37.5	$-0.018 * \text{age} + 1.78$
	37.5 - 70	$-0.01 * \text{age} + 1.45$
Male	2 - 5	$0.16 * \text{age} + 0.3$
	5 - 12.5	$0.06 * \text{age} + 0.8$
	12.5 - 18.8	$0.008 * \text{age} + 1.45$
	18.8 - 39.2	$-0.01 * \text{age} + 1.78$
	39.2 - 70	$-0.009 * \text{age} + 1.75$

For each and gender group specified in table 3.1, the walking speed should be modelled as a statistical uniform distribution having minimum and maximum values as follows:

Table 3.4 – Walking speed on flat terrain (e.g., corridors)

Population groups – passengers	Walking speed on flat terrain (e.g., corridors)	
	Minimum (m/s)	Maximum (m/s)
Females younger than 30 years	0.93	1.55
Females 30-50 years old	0.71	1.19
Females older than 50 years	0.56	0.94
Females older than 50, mobility impaired (1)	0.43	0.71
Females older than 50, mobility impaired (2)	0.37	0.61
Males younger than 30 years	1.11	1.85
Males 30-50 years old	0.97	1.62
Males older than 50 years	0.84	1.4
Males older than 50, mobility impaired (1)	0.64	1.06
Males older than 50, mobility impaired (2)	0.55	0.91
Population groups – crew	Walking speed on flat terrain (e.g., corridors)	
	Minimum (m/s)	Maximum (m/s)
Crew females	0.93	1.55
Crew males	1.11	1.85

³ Maritime EXODUS V4.0, USER GUIDE AND TECHNICAL MANUAL, Authors: E R Galea, S Gwynne, P. J. Lawrence, L. Filippidis, D. Blackshields and D. Cooney, CMS Press, May 2003 Revision 1.0, ISBN: 1 904521 38 X.

3.2.4 Unhindered stair speeds⁴

Speeds are given on the base of gender, age and travel direction (up and down). The speeds in table 3.5 are those along the inclined stairs. It is expected that all the data above will be updated when more appropriate data and results become available.

Table 3.5 – Walking speed on stairs

Population groups – passengers	Walking speed on stairs (m/s)			
	Stairs down		Stairs up	
	Min.	Max.	Min.	Max.
Females younger than 30 years	0.56	0.94	0.47	0.79
Females 30-50 years old	0.49	0.81	0.44	0.74
Females older than 50 years	0.45	0.75	0.37	0.61
Females older than 50, mobility impaired (1)	0.34	0.56	0.28	0.46
Females older than 50, mobility impaired (2)	0.29	0.49	0.23	0.39
Males younger than 30 years	0.76	1.26	0.5	0.84
Males 30-50 years old	0.64	1.07	0.47	0.79
Males older than 50 years	0.5	0.84	0.38	0.64
Males older than 50, mobility impaired (1)	0.38	0.64	0.29	0.49
Males older than 50, mobility impaired (2)	0.33	0.55	0.25	0.41
Population groups – Crew	Walking speed on stairs (m/s)			
	Stairs down		Stairs up	
	Min.	Max.	Min.	Max.
Crew females	0.56	0.94	0.47	0.79
Crew males	0.76	1.26	0.5	0.84

3.2.5 Exit flow rate (doors)

The specific unit flow rate is the number of escaping persons past a point in the escape route per unit time per unit width of the route involved, and is measured in number of persons (p). The specific unit flow rate⁵ for any exit should not exceed 1.33 p/(m s).

3.3 *Category ENVIRONMENTAL*

Static and dynamic conditions of the ship. These parameters will influence the moving speed of persons. Presently no reliable figures are available to assess this effect, therefore these parameters could not yet be considered. This effect will not be accounted for in the scenarios (cases 1, 2, 3 and 4) until more data has been gathered.

⁴ The maximum unhindered stair speeds are derived from data generated by J. Fruin. Pedestrian planning and design, Metropolitan Association of Urban Designers and Environmental Planners, New York, 1971. The study comprises two staircase configurations.

⁵ Value based on data accepted in civil building applications in Japan, the United Kingdom and the United States; this value is also consistent with the simplified evacuation analysis method.

3.4 *Category PROCEDURAL*

For the purposes of the four benchmark cases, it is not required to model any special crew procedures. However, the distribution of the crew for the benchmark cases should be in accordance with 4.

3.5 It is expected that all data provided in paragraphs 3.2 and 3.3 will be updated when more appropriate data and results become available.

4 **Detailed specifications (scenarios) for the 4 cases to be considered**

For the purpose of conducting the evacuation analysis, the following initial distributions of passengers and crew should be considered as derived from chapter 13 of the FSS Code, with the additional indications only relevant for the evacuation analysis. If the total number of persons on board calculated as indicated in the following cases exceeds the maximum number of persons the ship will be certified to carry, the initial distribution of persons should be scaled down so that the total number of persons is equal to what the ship will be certified to carry.

4.1 *Case 1 (primary evacuation case, night)*

Passengers in cabins with maximum berthing capacity fully occupied; 2/3 of crew members in their cabins; of the remaining 1/3 of crew members:

- .1 50% should be initially located in service spaces and behave as passengers having walking speed and reaction time as specified in paragraph 3;
- .2 25% should be located at their emergency stations and should not be explicitly modelled; and
- .3 25% should be initially located at the assembly stations and should proceed towards to the most distant passenger cabin assigned to that assembly station in counterflow with evacuees; once this passenger cabin is reached, these crew are no longer considered in the simulation. The ratio between the passenger and counterflow crew should be the same in each main vertical zone.

4.2 *Case 2 (primary evacuation case, day)*

Public spaces, as defined by SOLAS regulation II-2/3.39, will be occupied to 75% of maximum capacity of the spaces by passengers. Crew will be distributed as follows:

- .1 1/3 of the crew will behave as passengers with crew's walking speeds and reaction times as specified in paragraph 3 and being initially distributed in the crew cabins;
- .2 1/3 of the crew will behave as passengers with crew's walking speeds and reaction times as specified in paragraph 3 and being initially distributed in the public spaces;

- .3 the remaining 1/3 should be distributed as follows:
 - .1 50% should be located in service spaces and behave and a specified as in paragraph 4.2.1;
 - .2 25% should be located at their emergency stations and should not be explicitly modelled; and
 - .3 25% should be initially located at the assembly stations and should proceed towards to the most distant passenger cabin assigned to that assembly station in counterflow with evacuees; once this passenger cabin is reached, these crew are no longer considered in the simulation. The ratio between the passenger and counterflow crew should be the same in each main vertical zone.

4.3 *Cases 3 and 4 (secondary evacuation case, night and day)*

In these cases only the main vertical zone, which generates the longest assembly time, is further investigated. These cases utilize the same population demographics as in case 1 (for case 3) and as in case 2 (for case 4). The following are two alternatives that should be considered for both case 3 and case 4. Alternative 1 should be considered if possible:

- .1 alternative 1: one complete run of the stairways having largest capacity previously used within the identified main vertical zone is considered unavailable for the simulation;
- .2 alternative 2: 50% of the persons in one of the main vertical zones neighbouring the identified main vertical zone are forced to move into the zone and to proceed to the relevant assembly station. The neighbouring zone with largest population should be selected.

5 **Procedure for calculating the travel time T**

5.1 The travel time, both that predicted by models and as measured in reality, is a random quantity due to the probabilistic nature of the evacuation process.

5.2 In total, a minimum of 50 different simulations should be carried out for each of the four-benchmark cases. This will yield, for each case, a total of at least 50 values of t_A .

5.3 These simulations should be made up of at least 10 different randomly generated populations (within the range of population demographics specified in paragraph 3). Simulations based on each of these different populations should be repeated at least 5 times. If these 5 repetitions produce insignificant variations in the results, the total number of populations analysed should be 50 rather than 10, with only a single simulation performed for each population.

5.4 The value of the travel time for each of the four cases: the value t_I is taken which is higher than 95% of all the calculated values (i.e., for each of the four cases, the times t_A are ranked from lowest to highest and t_R is selected for which 95% of the ranked values are lower).

5.5 The value of the travel time to comply with the performance standard T is the highest of the four calculated travel times t_I (one for each of the four cases).

6 Documentation of the simulation model used

6.1 The assumptions made for the simulation should be stated. Assumptions that contain simplifications above those in paragraph 3.2 of the Guidelines for the advanced evacuation analysis of new and existing passenger ships, should not be made.

6.2 The documentation of the algorithms should contain:

- .1 the variables used in the model to describe the dynamics, e.g., walking speed and direction of each person;
- .2 the functional relation between the parameters and the variables;
- .3 the type of update, e.g., the order in which the persons move during the simulation (parallel, random sequential, ordered sequential or other);
- .4 the representation of stairs, doors, assembly stations, embarkation stations, and other special geometrical elements and their influence on the variables during the simulation (if there is any) and the respective parameters quantifying this influence; and
- .5 a detailed user guide/manual specifying the nature of the model and its assumptions and guidelines for the correct use of the model and interpretations of results should be readily available.

6.3 The results of the analysis should be documented by means of:

- .1 details of the calculations;
- .2 the total evacuation time; and
- .3 the identified congestion points.

ANNEX 3**GUIDANCE ON VALIDATION/VERIFICATION OF
EVACUATION SIMULATION TOOLS**

1 Software verification is an ongoing activity. For any complex simulation software, verification is an ongoing activity and is an integral part of its life cycle. There are at least four forms of verification that evacuation models should undergo. These are*:

- .1 component testing;
- .2 functional verification;
- .3 qualitative verification; and
- .4 quantitative verification.

Component testing

2 Component testing involves checking that the various components of the software perform as intended. This involves running the software through a battery of elementary test scenarios to ensure that the major sub-components of the model are functioning as intended. The following is a non-exhaustive list of suggested component tests that should be included in the verification process.

Test 1: Maintaining set walking speed in corridor

3 One person in a corridor 2 m wide and 40 m long with a walking speed of 1 m/s should be demonstrated to cover this distance in 40 s.

Test 2: Maintaining set walking speed up staircase

4 One person on a stair 2 m wide and a length of 10 m measured along the incline with a walking speed of 1 m/s should be demonstrated to cover this distance in 10 s.

Test 3: Maintaining set walking speed down staircase

5 One person on a stair 2 m wide and a length of 10 m measured along the incline with a walking speed of 1 m/s should be demonstrated to cover this distance in 10 s.

Test 4: Exit flow rate

6 100 persons (p) in a room of size 8 m by 5 m with a 1 m exit located centrally on the 5 m wall. The flow rate over the entire period should not exceed 1.33 p/s.

Test 5: Response time

7 Ten persons in a room of size 8 m by 5 m with a 1 m exit located centrally on the 5 m wall. Impose response times as follows uniformly distributed in the range between 10 s and 100 s. Verify that each occupant starts moving at the appropriate time.

* Note: This procedure has been highlighted in ISO document ISO/TR 13387-8:1999.

Test 6: Rounding corners

8 Twenty persons approaching a left-hand corner (see figure 1) will successfully navigate around the corner without penetrating the boundaries.

Test 7: Assignment of population demographics parameters

9 Choose a panel consisting of males 30-50 years old from table 3.4 in the appendix to the Guidelines for the advanced evacuation analysis of new and existing ships and distribute the walking speeds over a population of 50 people. Show that the distributed walking speeds are consistent with the distribution specified in the table.

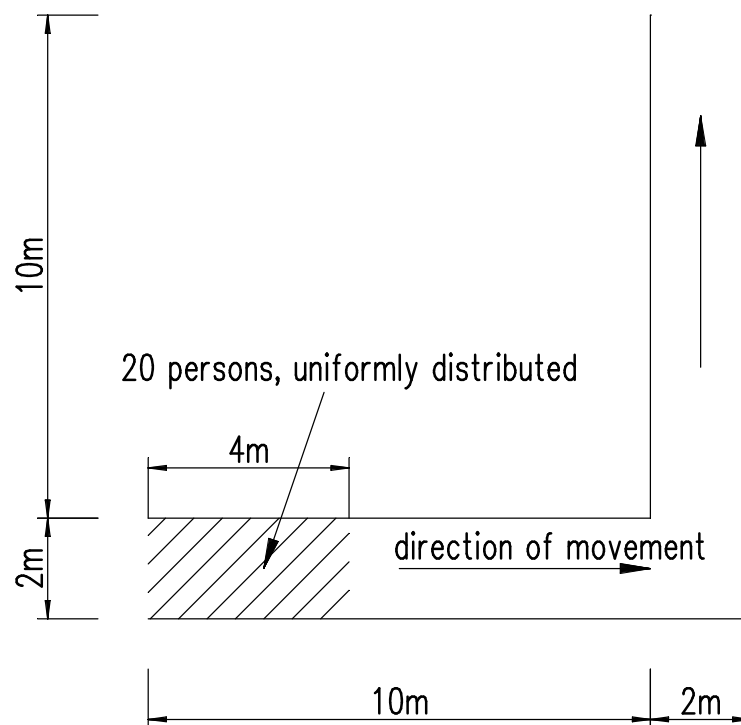

Figure 1: Transverse corridor

Functional verification

10 Functional verification involves checking that the model possesses the ability to exhibit the range of capabilities required to perform the intended simulations. This requirement is task specific. To satisfy functional verification the model developers must set out in a comprehensible manner the complete range of model capabilities and inherent assumptions and give a guide to the correct use of these capabilities. This information should be readily available in technical documentation that accompanies the software.

Qualitative verification

11 The third form of model validation concerns the nature of predicted human behaviour with informed expectations. While this is only a qualitative form of verification, it is nevertheless important, as it demonstrates that the behavioural capabilities built into the model are able to produce realistic behaviours.

Test 8: Counterflow – two rooms connected via a corridor

12 Two rooms 10 m wide and long connected via a corridor 10 m long and 2 m wide starting and ending at the centre of one side of each room. Choose a panel consisting of males 30-50 years old from table 3.4 in the appendix to the Guidelines for the advanced evacuation analysis of new and existing ships with instant response time and distribute the walking speeds over a population of 100 persons.

13 Step 1: One hundred persons move from room 1 to room 2, where the initial distribution is such that the space of room 1 is filled from the left with maximum possible density (see figure 2). The time the last person enters room 2 is recorded.

14 Step 2: Step one is repeated with an additional ten, fifty, and one hundred persons in room 2. These persons should have identical characteristics to those in room 1. Both rooms move off simultaneously and the time for the last persons in room 1 to enter room 2 is recorded. The expected result is that the recorded time increases with the number of persons in counterflow increases.

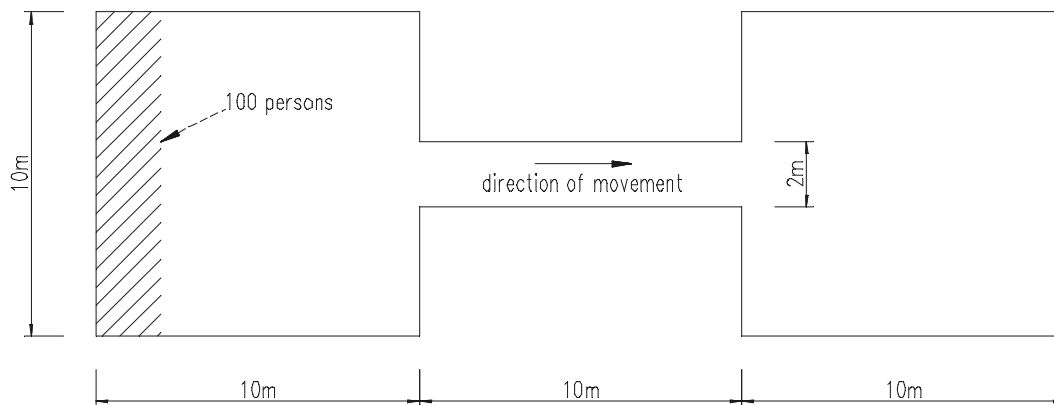

Figure 2: Two rooms connected via a corridor

Test 9: Exit flow: crowd dissipation from a large public room

15 Public room with four exits and 1,000 persons (see figure 3) uniformly distributed in the room. Persons leave via the nearest exits. Choose a panel consisting of males 30-50 years old from table 3.4 in the appendix to the Guidelines for the advanced evacuation analysis of new and existing ships with instant response time and distribute the walking speeds over a population of 1,000 persons.

Step 1: Record the time the last person leaves the room.

Step 2: Close doors 1 and 2 and repeat step 1.

The expected result is an approximate doubling of the time to empty the room.

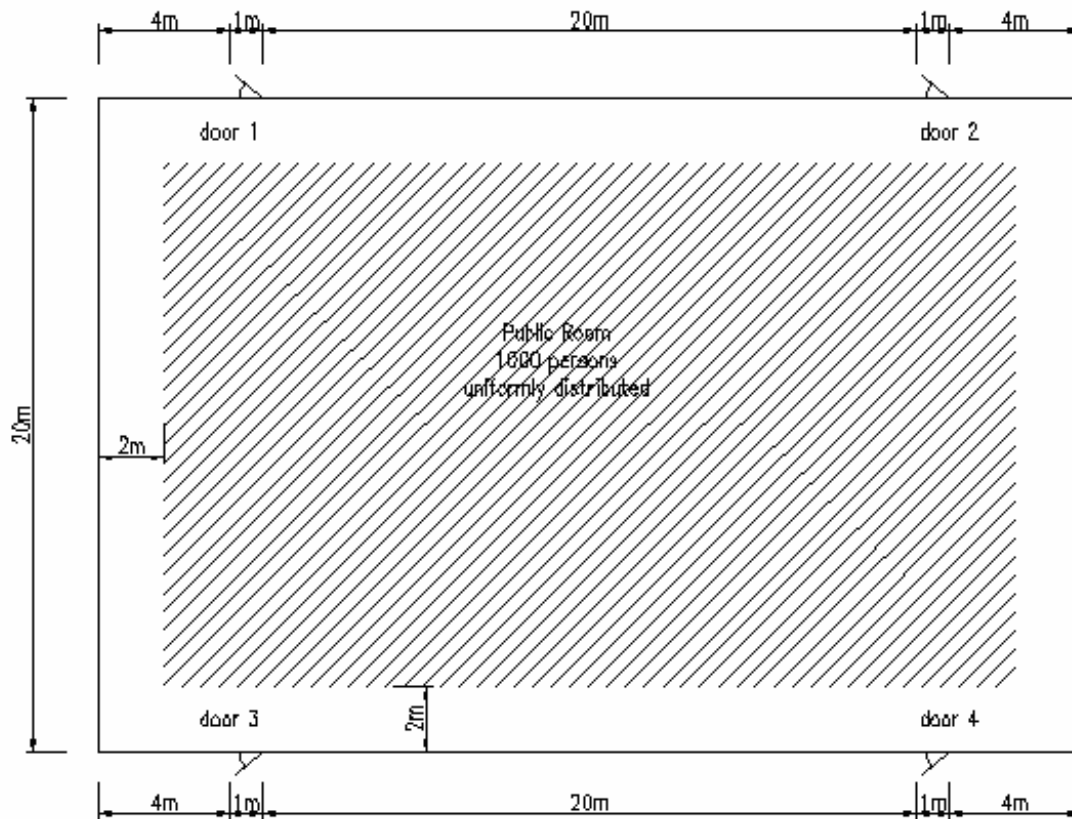

Figure 3: Exit flow from a large public room

Test 10: Exit route allocation

16 Construct a cabin corridor section as shown in figure 3 populated as indicated with a panel consisting of males 30-50 years old from table 3.4 in the appendix to the Guidelines for the advanced evacuation analysis of new and existing ships with instant response time and distribute the walking speeds over a population of 23 persons. The people in cabins 1, 2, 3, 4, 7, 8, 9, and 10 are allocated the main exit. All the remaining passengers are allocated the secondary exit. The expected result is that the allocated passengers move to the appropriate exits.

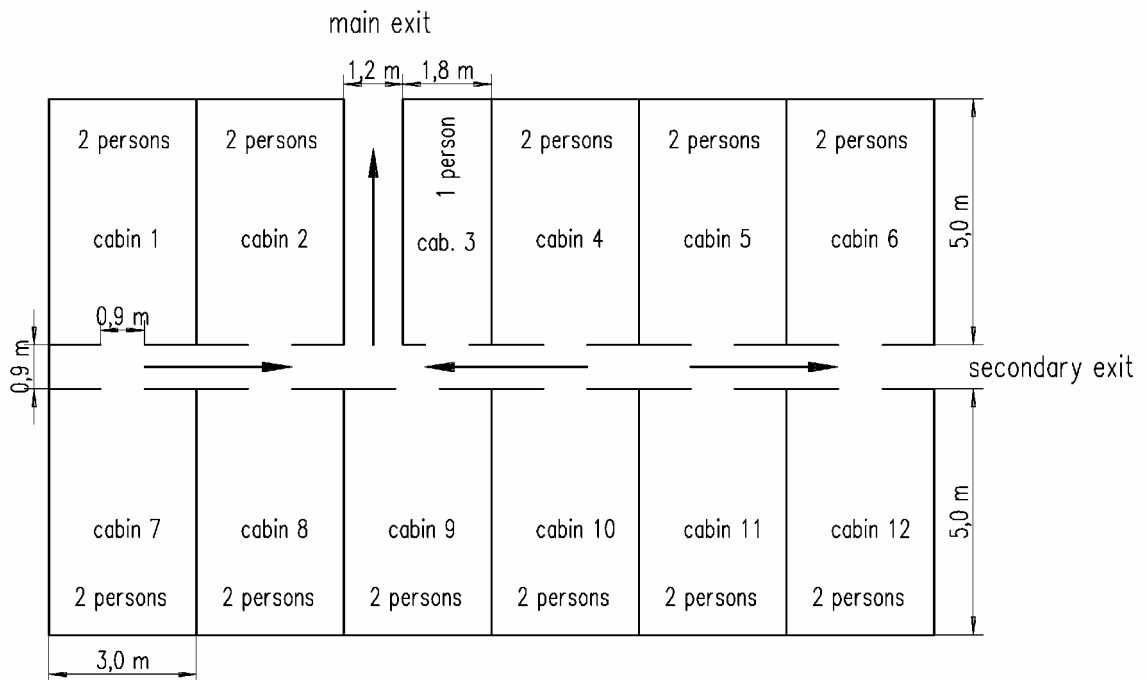

Figure 4: Cabin area

Test 11: Staircase

17 Construct a room connected to a stair via a corridor as shown in figure 4 populated as indicated with a panel consisting of males 30-50 years old from table 3.4 in the appendix to the Guidelines for the advanced evacuation analysis of new and existing ships with instant response time and distribute the walking speeds over a population of 150 persons. The expected result is that congestion appears at the exit from the room, which produces a steady flow in the corridor with the formation of congestion at the base of the stairs.

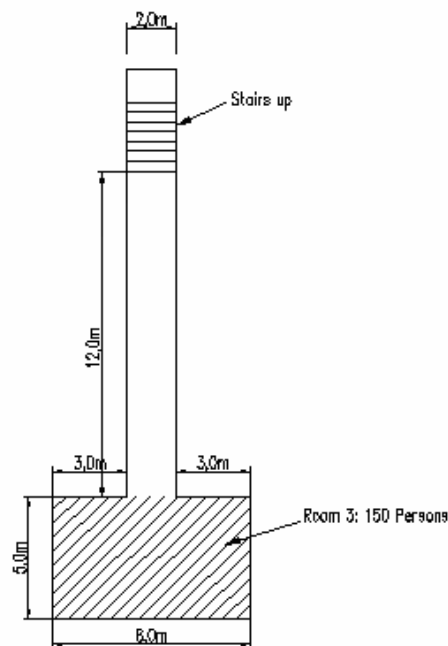

Figure 5: Escape route via stairs

Quantitative verification

18 Quantitative verification involves comparing model predictions with reliable data generated from evacuation demonstrations. At this stage of development there is insufficient reliable experimental data to allow a thorough quantitative verification of egress models. Until such data becomes available the first three components of the verification process are considered sufficient.
